

3314 H

# DC axial compact fan



## ebm-papst St. Georgen GmbH & Co. KG

Hermann-Papst-Straße 1

D-78112 St. Georgen

Phone +49 7724 81-0

Fax +49 7724 81-1309

info2@de.ebmpapst.com

www.ebmpapst.com

## Nominal data

Type	3314 H	
Nominal voltage	VDC	24
Nominal voltage range	VDC	12 .. 28
Speed	min <sup>-1</sup>	4000
Power input	W	5.3
Min. ambient temperature	°C	-20
Max. ambient temperature	°C	75
Air flow	m <sup>3</sup> /h	107
Sound power level	B	6.0
Sound pressure level	dB(A)	47

ml = max. load · me = max. efficiency · fa = running at free air · cs = customer specs · cu = customer unit  
Subject to alterations



## Technical features

<b>General description</b>	<p>Particular design features:</p> <p>Ball bearings and sleeve bearings available.</p> <p>Optional Vario-Pro: Highly flexible software configuration for the fan ensures an easily customisable solution to meet the individual requirements of your application.</p> <p>General features:</p> <p>Material: fibreglass-reinforced plastic. Impeller PA, housing PBT.</p> <p>Electronic commutation completely integrated.</p> <p>Protected against reverse polarity and locking.</p> <p>Connection via single strands AWG 22, TR 64, bared and tin-plated.</p> <p>Air exhaust over bars. Rotational direction clockwise looking at rotor.</p> <p>Mass: 190 g.</p>
<b>Mass</b>	0.190 kg
<b>Dimensions</b>	92 x 92 x 32 mm
<b>Material of impeller</b>	Fiberglass-reinforced PA plastic
<b>Housing material</b>	Fiberglass-reinforced PBT plastic
<b>Direction of air flow</b>	Air exhaust over bars
<b>Direction of rotation</b>	Right, looking at rotor
<b>Bearing</b>	Ball bearings
<b>Lifetime L10 at 40 °C</b>	57500 h
<b>Lifetime L10 at maximum temperature</b>	25000 h
<b>Connection line</b>	Single strands AWG 22, TR 64, bared and tin-plated.
<b>Motor protection</b>	Protected against reverse polarity and locking.
<b>Approval</b>	VDE, CSA, UL

## Product drawing

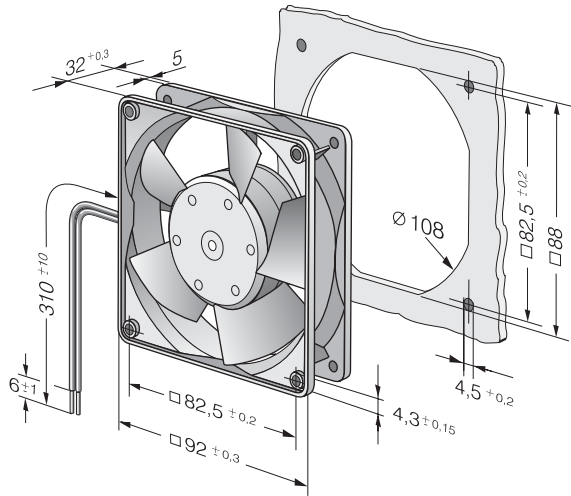

## Charts: Air flow

