

**ebm-papst St. Georgen GmbH & Co. KG**

Hermann-Papst-Str. 1
 D-78112 St. Georgen
 Phone +49 (0) 7724 81-0
 Fax +49 (0) 7724 81-1309
 info2@de.ebmpapst.com
 www.ebmpapst.com

Nominal data

Type	8212 JH4	
Nominal voltage	VDC	12
Nominal voltage range	VDC	6 .. 13.8
Speed	min ⁻¹	14000
Power input	W	39
Min. ambient temperature	°C	-20
Max. ambient temperature	°C	70
Air flow	m ³ /h	222
Sound power level	B	7.8
Sound pressure level	dB(A)	71

ml = Max. load · me = Max. efficiency · fa = Running at free air · cs = Customer specs · cu = Customer unit
 Subject to alterations



Technical features

General description	* Free air power consumption, these values may be considerably higher at the operating point.
Housing material	Fibreglass-reinforced plastic (PBT)
Impeller material	Fibreglass-reinforced plastic (PA)
Mass	0.200 kg
Dimensions	80 x 80 x 38 mm
Direction of air flow	Air exhaust over bars
Direction of rotation	Left, looking at rotor
Bearing	Ball bearings
Lifetime L10 at 40 °C	50000 h
Lifetime L10 at maximum temperature	25000 h
Connection line	Single strands AWG 22, TR 64, bared and tin-plated.
Motor protection	Protected against reverse polarity and locking.
Option	Speed signal

Product drawing

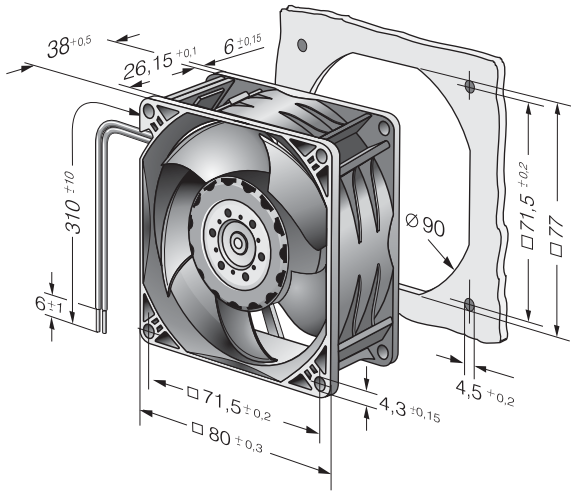

Charts: Air flow

