

**ebm-papst St. Georgen GmbH & Co. KG**

Hermann-Papst-Str. 1  
 D-78112 St. Georgen  
 Phone +49 (0) 7724 81-0  
 Fax +49 (0) 7724 81-1309  
 info2@de.ebmpapst.com  
 www.ebmpapst.com

**Nominal data**

Type	8214 JN	
Nominal voltage	VDC	24
Nominal voltage range	VDC	18 .. 26.4
Speed	min <sup>-1</sup>	8400
Power input	W	11
Min. ambient temperature	°C	-20
Max. ambient temperature	°C	70
Air flow	m <sup>3</sup> /h	132
Sound power level	B	6.6
Sound pressure level	dB(A)	55

ml = Max. load · me = Max. efficiency · fa = Running at free air · cs = Customer specs · cu = Customer unit  
 Subject to alterations

### Technical features

<b>General description</b>	* Free air power consumption, these values may be considerably higher at the operating point.
<b>Housing material</b>	Fibreglass-reinforced plastic (PBT)
<b>Impeller material</b>	Fibreglass-reinforced plastic (PA)
<b>Mass</b>	0.160 kg
<b>Dimensions</b>	80 x 80 x 38 mm
<b>Direction of air flow</b>	Air exhaust over bars
<b>Direction of rotation</b>	Left, looking at rotor
<b>Bearing</b>	Ball bearings
<b>Lifetime L10 at 40 °C</b>	62500 h
<b>Lifetime L10 at maximum temperature</b>	32500 h
<b>Connection line</b>	Single strands AWG 24, TR 64, bared and tin-plated.
<b>Motor protection</b>	Protected against reverse polarity and locking.
<b>Locked-rotor protection</b>	With electronic blocking and overload protection
<b>Approval</b>	CE
<b>Option</b>	Speed signal

## Product drawing

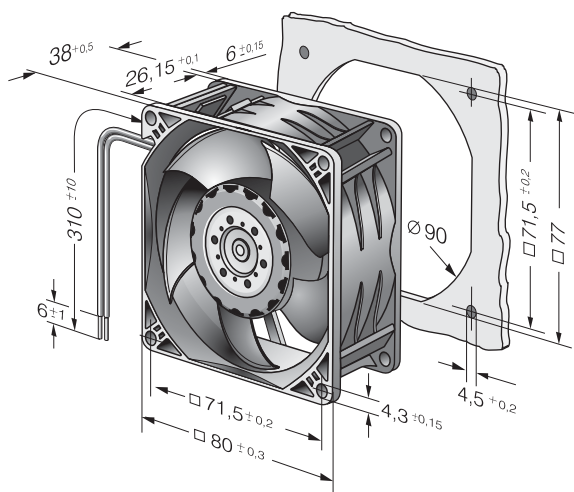

## Charts: Air flow

