

4840 N

# AC axial compact fan



## ebm-papst St. Georgen GmbH & Co. KG

Hermann-Papst-Str. 1  
D-78112 St. Georgen  
Phone +49 (0) 7724 81-0  
Fax +49 (0) 7724 81-1309  
info2@de.ebmpapst.com  
www.ebmpapst.com

## Nominal data

Type	4840 N	
Phase		1~
Nominal voltage	VAC	115
Frequency	Hz	60
Speed	min <sup>-1</sup>	1650
Power input	W	10.0
Min. ambient temperature	°C	-10
Max. ambient temperature	°C	75
Air flow	m <sup>3</sup> /h	85
Sound power level	B	4.1
Sound pressure level	dB(A)	26

ml = Max. load · me = Max. efficiency · fa = Running at free air · cs = Customer specs · cu = Customer unit  
Subject to alterations



**Technical features**

<b>Mass</b>	0.550 kg
<b>Dimensions</b>	119 x 119 x 38 mm
<b>Material of impeller</b>	Sheet steel, coated in black
<b>Housing material</b>	Die-cast aluminium
<b>Direction of air flow</b>	Exhaust over struts
<b>Direction of rotation</b>	Right, looking at rotor
<b>Bearing</b>	Sintec sleeve bearing
<b>Lifetime L10 at 40 °C</b>	57500 h
<b>Lifetime L10 at maximum temperature</b>	25000 h
<b>Connection line</b>	2 flat plugs 3.0 x 0.5 mm. Housing with grounding lugs for screw M4 and UNC.
<b>Motor protection</b>	Protected from overload using impedance protection
<b>Approval</b>	VDE, CSA, UL, CE



## Product drawing

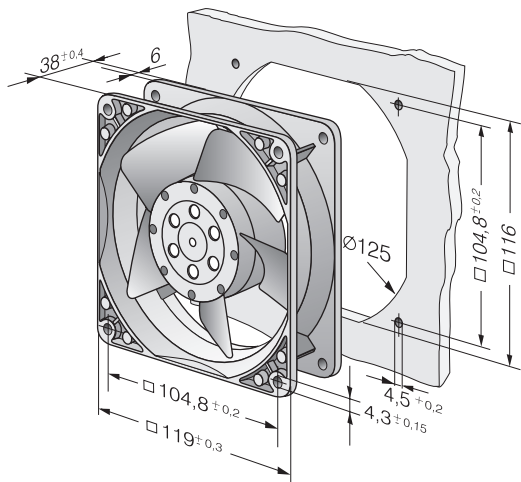

## Charts: Air flow

